

Construction Site Contingency Plan for Erosion Control and Emergency Spills

For the:
5 Research Parkway Re-Development

Located at:
5 Research Parkway
Wallingford, Connecticut

Prepared for Submission to:
**Town of Wallingford
Land Use Agencies**

October 20, 2020
Revised: December 21, 2020
February 24, 2021
March 18, 2021
April 20, 2021
June 11, 2021

Prepared by:
BL Companies
355 Research Parkway
Meriden, Connecticut 06450
Phone: (203) 630-1406 Fax (203) 630-2615

Prepared for:
Montante Construction
2760 Kenmore Avenue
Buffalo, NY 14150

Table of Contents

Erosion Control Contingency Plan	1
Erosion Control Scope.....	1
Storm Hazard Awareness.....	1
Perimeter Barrier Protections	1
Sediment Traps	1
Level Spreaders, Plunge Pools and Anti-Tracking Aprons	2
Diversion Swales/Trenches	2
Stockpiles	2
Existing Ponds/Dam	2
Catch Basin Inlet Protection	2
Erosion Control Storage Containers, Vehicle, and Equipment Storage Areas	2
Storm Checklist.....	2
Post Storm Inspection and Repair.....	3
Emergency Spill Prevention, Response and Clean-Up Procedures.....	4
Hazardous Materials Use	4
Equipment and Materials	4
Site Management and Spill Prevention	5
Inspection and Leak Detection	5
Spill Event and Clean-Up Procedures	5-6

Attachments

Contingency Plan Sheets EC-43 and EC-44

Erosion Control Contingency Plan

Erosion Control Scope

This plan has been prepared at the request of the Town of Wallingford's Environmental Planner and is intended to supplement, not replace, the requirements set forth in the construction documents and CT DEEP General Permit for Discharge of Stormwater and Dewatering Wastewaters from Construction Activities for this site or any other applicable regulations.

Storm Hazard Awareness

- The site Project Safety Manager/Site Construction Manager will designate an observer to monitor real time weather radar and warn the Site Construction Manager and team of approaching storm events. The Site Construction Manager will appoint a person to be in charge of inspecting erosion and sedimentation controls prior to, during and after the storm event. This may be a storm event that is not a major catastrophic event such as a hurricane or tropical storm but an intense short duration rainfall producing several inches of water in a short period of time or a series of several continuous days of rainfalls.
- Prior to, during and after the storm event the below measures are to be taken to ensure that the erosion and sedimentation controls are installed correctly and working properly. Any deficiencies shall be repaired and/or addressed as soon as possible.

Perimeter Barrier Protections

- Ensure perimeter erosion control barriers for proper installation and maintenance. Remove excess soils that have built up along the fence to assure maximum storage areas. Fix any areas that may be damaged.
- Any perimeter barriers damaged during storm events should be repaired immediately.

Sediment Traps

- Clean sediment traps and/or stormwater detention ponds prior to storm events. Make sure all inlets and outlets are clear of sediment and debris.
- If severe weather events are predicted and water surface elevations have not fully receded from prior storm events, the trap(s) may be pumped to the designated dewatering areas. Ensure all temporary sediment traps are drawn down.
- Spillways and the haybale and stone check dams at the inlets and outlets should be inspected prior to storm events and cleaned of accumulated sediment, repaired or fortified as required.
- Flocculants should be readily available and be prepared to be deployed if runoff into the traps appears to be turbid. If necessary, as directed by the Erosion and Sediment Control Inspector and approved by the Wallingford Water Division, Environmental Planner and the Engineer: additional flocculants will be installed at the trap inlets and outlets.

Level Spreaders, Plunge Pools, and Anti-Tracking Aprons

- Level Spreaders, Plunge Pools, and Anti-Tracking Aprons shall be inspected for and measures taken to rectify any issues prior to severe storm event including removal of accumulated sediment and/or debris.
- Additional riprap or stone shall be installed where there is evidence of scouring.

Diversion Swales/Trenches

- Diversion swales/trenches shall be inspected for and measures taken to rectify any issues prior to a storm event including removal of accumulated sediment, replacing erosion blankets and/or riprap as required.
- Stone check dams shall be inspected regularly, and any accumulated sediment shall be removed.
- If necessary, as directed by the Erosion and Sediment Control Inspector and approved by the Wallingford Water Division, Environmental Planner and Engineer additional flocculants will be installed in the swales/trenches.

Stockpiles

- Inspect and repair any erosion control measure surrounding stockpile areas.
- Add an additional row of silt fence if the stockpiles are actively being used and are not stabilized with vegetated growth.

Existing Ponds / Dam

- The existing ponds will have the water surfaces lowered prior to commencement of construction. Prior to a major storm event and/or consecutive storm events, the ponds water surfaces shall be inspected to assure the proper drawdown level has been maintained. The appropriate drawdown levels are as follow:
 - Smaller pond: 24" or approximately elevation 331.5
 - Larger pond: 12" or approximately elevation 329.0
- Lowering of the water surface within the ponds shall be subject to the review and approval of the Wallingford Water Division: the existing ponds may be required to have the water surface lowered to a level prescribed by the Water Division different than above. Any associated work shall be approved by the Wallingford Environmental Planner.
- The timing of lowering the water surface shall be at the discretion of the Wallingford Environmental Planner in conjunction with the Water Division.
- The water surface elevation drawdown for the ponds shall be executed simultaneously.
- Prior to drawdown, the following materials shall be provided and staged on site:
 - Smaller pond:
 - Temporary slide gate designed to lower pond 24". This shall be a uniform sheet of stainless steel or approved other of width to securely fit inside the slide gate rails. The height of the gate shall be of the dimension necessary to lower the water surface elevation by 24".
 - Temporary inflatable plug for cross-culvert
 - Turbidity curtain of sufficient length to completely isolate the inlet structure
 - Turbidity curtain of sufficient length to isolate the cross-culvert outlet.
 - Stand-by pump sufficient to pump a minimum of 200 gpm and dewatering bag (or approved alternative)
 - Larger pond:
 - Orifice riser including grate and adaptor to existing outlet pipe intake. Reference plan sheet EC-44 for more detailed information
 - Turbidity curtain
 - Approved materials for temporary coffer dam to be constructed at intake
 - Stand-by pump sufficient to pump a minimum of 200 gpm and dewatering bag (or approved alternative)
- Each pond water surface elevation shall be lowered as follows:
 - Smaller pond:
 1. Provide turbidity curtain at cross culvert outlet located within the larger pond

2. Install a temporary inflatable plug insert into the cross-culvert inlet within the smaller pond outlet structure immediately downstream of the slide gate.
 3. Remove existing slide gate and salvage for later re-use upon completion and approval of all site work
 4. Install new lower slide gate
 5. Remove temporary inflatable plug
- Larger pond:
 1. Install coffer dam around proposed pipe riser work area
 2. Dewater work area
 3. Install pipe riser to elevation 12" beneath dam invert elevation
 4. Utilizing the existing gate valve located adjacent to the existing dam. The gate valve shall be turned slowly and discharge monitored for sediment laden water. Should the turbidity of the discharge not be acceptable, the valve will be closed immediately.
 - The Contractor shall maintain pump capabilities on-site should the gate valve fail to operate. The Contractor shall provide for review a pumping plan to the Wallingford Environmental Planner prior to commencement of construction.
 - Flocculants should be readily available and be prepared to be deployed if runoff into the ponds appears to be turbid. If necessary, additional flocculants will be installed at the pond inlets. Application rate of flocculants shall be as prescribed by Applied Polymer Systems Inc. or approved equal and as prescribed by the manufacturer but shall not exceed the concentration allowed under NSF 60 for drinking water treatment plant.
 - Turbidity curtains shall be readily available and be prepared to be deployed.
 - The existing draw down valve shall be tested by the Owner prior to commencement of any sitework.
 - The site Contractor shall maintain dewatering pump capability onsite in the event the draw down valve fails, and the pond must be pumped down to the approved level.

Pedestrian Crossing Stop-Log Installation

- Prior to commencement of any site work, Stop-Log brackets shall be installed on the pedestrian bridge concrete abutments as depicted on plan sheets EC-44 and as directed by the Engineer.
- The Stop-Logs shall be staged in close proximity to their application locations.
- Stop logs shall be installed at a prescribed level (number of boards) prior to a severe storm event and/or as directed by the Project Engineer subject to the review and approval by the Wallingford Environmental Planner, Town Engineer and Water Division.
- Upon conclusion of the storm event, the Stop-Logs shall be inspected by the Project Engineer prior to removal. All accumulated sediments are to be removed prior to removal of Stop-Logs by method approved by the Engineer.

Catch Basin Inlet Protection

- Remove silt sack inlet protections at catch basins on Carpenter Lane and Research Parkway prior to severe storm events to prevent flooding in low lying areas along the roadways. Replace immediately after conclusion of the storm event.

Erosion Control Storage Containers, Vehicle, and Equipment Storage Areas

- De-watering pumps and generators are to be available for preparations prior to the storm and repairs after the storm.
- Additional erosion control measures are to be stored on site in the areas designated on the plans and shall be readily available to fix any issues that may arise during and after the storm event. Check erosion control storage containers to make sure they are fully stocked

with additional silt fence, silt socks, turbidity curtains, and flocculant. Products used during the storm will be restocked as soon as possible.

- Hazardous materials/supplies are to be securely locked and stored high and dry in on-site storage trailers.

Storm Checklist

- Prior to the any major storm events such as tropical storms, hurricanes or a forecasted period of multiple rainy days in a row follow; the below time guidelines for erosion control:

72-hours Prior to Storm

- Confirm that all emergency contact information is current (i.e. phone numbers, email addresses, etc.)
- Verify that all erosion and sediment control devices as noted above and as added to the erosion control plan are in place and meet adequate standards.
- Verify all contingency devices are properly staged for deployment.
- Prioritize workplan to minimize any open excavations.
- Ensure that the jobsite weather radio is working and has back up batteries.

48-hours Prior to Storm

- Review 72-hour Checklist.
- Notify contractors of unsecured trailers and storage containers to anchor them or remove them from the site.
- Review site drainage patterns and relocate materials stored in lowlands.

24-hours Prior to Storm

- Review 48-hour checklist.
- Document the status of the project with pictures and store them in a dry secure place.
- All incomplete piping is to be capped to prevent sand infiltration.
- Take pictures of site conditions.

12-hours Prior to Storm

- Review 24-hour checklist.
- Turn off water, power, gas, etc. at source.
- Evacuate site.
- Take pictures of any changes to the construction site conditions.

Post Storm Inspection and Repair

- As soon as possible after the storm event inspect the erosion control measures.
- Make necessary repairs immediately.
- Restock erosion control storage containers.

Emergency Spill Prevention, Response and Clean-up Procedures

These procedures provide guidance for the prevention of spills of hazardous materials, and the notification, clean-up, and reporting of releases should they occur during construction at 5 Research Parkway.

Hazardous Materials Use

All hazardous materials shall be stored high and dry in secure locked construction storage trailers. Prior to construction, the contractor will verify the types of hazardous materials to be used during construction, and the personnel who will be responsible for oversight of the subject materials. The contractor will be obligated to establish secure storage sites and manage all materials. Personnel who will be responsible for hazardous materials used during the construction process include the Site Construction Manager, the Environmental Monitor, and any job-site coordinators designated by the Site Construction Manager. These individuals have the authority to commit the resources needed to prevent spills, and if necessary, conduct the containment and clean-up of spills as a part of the project. These individuals also have the authority to contact the DEEP and the Wallingford Water Division to notify them of any spills.

All hazardous products, shall be transported, stored, and used in compliance with applicable labels, regulations, and permit conditions. No incompatible materials shall be mixed or stored together. There shall be two (2) containers stored on-site at all times during construction. One shall be stored in the northern portions of the site and the other in the southern portion of the site. Compliance with all applicable regulations, including those relating to proper labeling, retention of SDS sheets, compatibility requirements, containers, and housekeeping shall be the responsibility of the contractor. Drums and containers will be clearly labeled and stored with all labels visible. All flammable products will be stored away from heat and/or ignition sources. All transportation of hazardous materials shall occur in compliance with all applicable federal, state, and local regulations and permit conditions.

Equipment and Materials

The contractor shall keep on-hand appropriate equipment, supplies, and materials for containment and clean-up of chemicals, in the event of a spill. There shall be two (2) containers located on site at all times. One container shall be located in the northern portion of the site and the other in the southern portion. Each container shall at minimum contain the following:

- Spill Kits for Construction Equipment.
- Sorbents for containment and quick pickup of spilled liquids.
- Shovels, backhoes, etc. for excavation of contaminated materials.
- Drums, barrels, temporary storage bags for containment and transportation.
- Absorbent pads, oil booms, mats, or equivalent.
- Washable, reusable rags for cleaning up small lubricant leaks onto machinery.
- Sheet plastic.
- The above listed materials and dry powder and any other material for use in oil spill clean-up will be stored at the main contractor's jobsite designated storage trailer. All construction and maintenance personnel will be notified of the location of materials used to contain spills.

Site Management and Spill Prevention

The following measures should be implemented to ensure the proper storage and disposal of construction site wastes:

- Designate waste collection areas that do not receive significant runoff from upland areas and that are not adjacent to waterbodies.
- Cover waste containers.
- Schedule waste collection at appropriate intervals to prevent overfilling of containers.
- There will be no washing of vehicles or equipment on-site.
- Clean up any spills immediately and dispose of in accordance with applicable state and local laws.
- Maintain (contractor) adequate spill prevention materials (e.g., absorbent pads, booms) on-site.
- No petroleum products other than those used for small equipment such as small soil compactors and cut off saws shall be stored on-site. Fuel trucks or fuel storage tanks to fuel equipment shall not be stored on site.
- Equipment shall only be fueled within the fueling pads with adequate containment as indicated on the plans.
- Storage areas and waste containers should be included in the regular inspection program of the site.

Inspection and Leak Detection

Construction contractors, managers, and facility operators shall conduct routine inspections of equipment and facilities, including construction equipment, delivery vehicles, transformers and any other potential sources of hazardous releases. Equipment and facilities will be inspected on a routine basis for leaks of potential hazardous materials and for integrity of containment should where applicable (e.g., transformers). Any leaks shall be addressed in a timely manner in accordance with all applicable regulations.

Spill Event and Clean-up Procedures

In the event of a spill occurrence, the following actions are to be taken:



- Notify Wallingford Fire Department, Wallingford Water Division and DEEP.
- Contain the release.
- Contain the release using absorbent or absorbent socks or booms to minimize the extent of the spill;
- Protect sensitive receptors such as drains, storm drains, surface water bodies, and minimize the amount of uncontrolled release;
- Cordon off the spill area with "CAUTION" tape. The area should consist of the entire spill area plus a buffer of at least three feet;
- For spills less than 5 gallons on an impervious surface, attempt to confine and clean the spill;
- For spills greater than 5 gallons, attempt to confine the spill and call a remediation contractor if assistance is required with product recovery and containment;
- Corrosive spills should be neutralized using an appropriate neutralizing agent;
- Clean up the spill from the perimeter inward using appropriate absorbent (clays, pads, pillows, etc.);
- Collect all contaminated media in drums, if quantities permit;
- Clean all reusable equipment using rags and cleaners as appropriate;

- Dispose of all disposable equipment (e.g., PPE) in drums;
- Document the spill and report to the proper authorities.
- For spills greater than 5 gallons, report to DEEP, Wallingford Water Division and Wallingford Fire Department.
- Provide written documentation of the spill.

An up-to-date list of qualified emergency response contractors with the capability of reaching the project site quickly shall be on site and known to the contractor prior to construction. If a heavy fuel or oil spill occurs, then the contaminated soil will be removed from the worksite and disposed of in an appropriate permitted landfill. Testing may be required to determine the appropriate method for disposal. This shall be performed by a Certified person, and analytical testing shall be completed and documented. Based upon the results of the analytical testing, the material may be taken to either an approved solid waste landfill or an approved hazardous waste treatment and disposal facility. No disposal of materials on-site is permitted.

ATTACHMENT
Contingency Plan Sheets EC-43 and EC-44

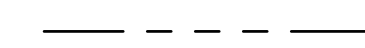
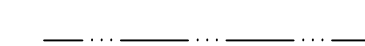
LEGEND

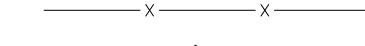
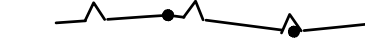
-  Property Line
-  Easement Line
-  Edge of Water
-  Stone Wall
-  Fence
-  Limit of Wetlands
-  Zone Line

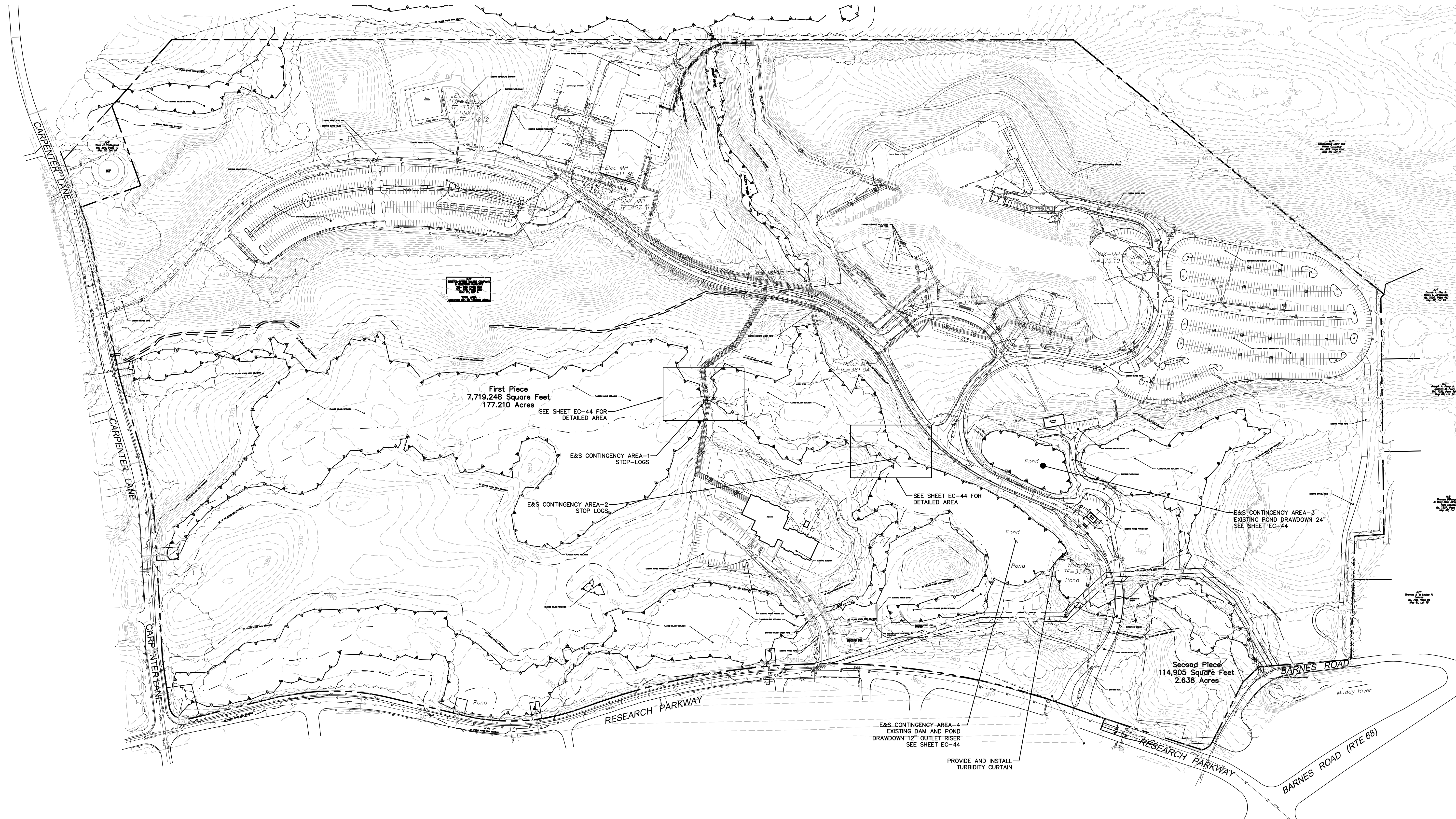
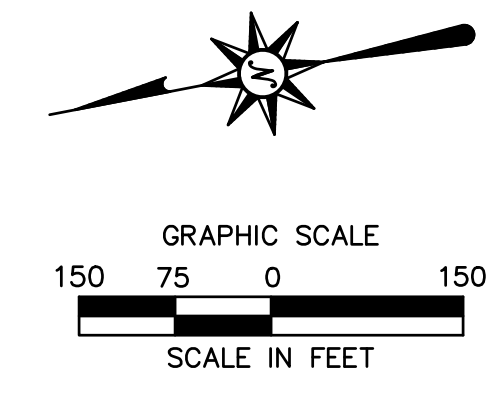

**THE SITE LIES ENTIRELY WITHIN A
PUBLIC WATER SUPPLY**

**FOR PERMITTING PURPOSES ONLY
NOT RELEASED FOR CONSTRUCTION**



355 Research Parkway
Meriden, CT 06450
(203) 630-1406
(203) 630-2615 Fax



PROPOSED DEVELOPMENT
5 RESEARCH PARKWAY
WALLINGFORD, CONNECTICUT

DESIGNED: JD
DRAWN: NAN
REVIEWED: C.D.G.
SCALE: 1"=150'
PROJECT NO.: 1901479
DATE: 12/21/2020

CAD FILE: EC190147905

**EROSION
CONTROL
CONTINGENCY
PLAN**

Sheet No.

EC-43

5/13/2021, 09:51 AM, G:\0819\1901479\DWG\EC190147905.DWG, EC-43, 4x6.8, 150%

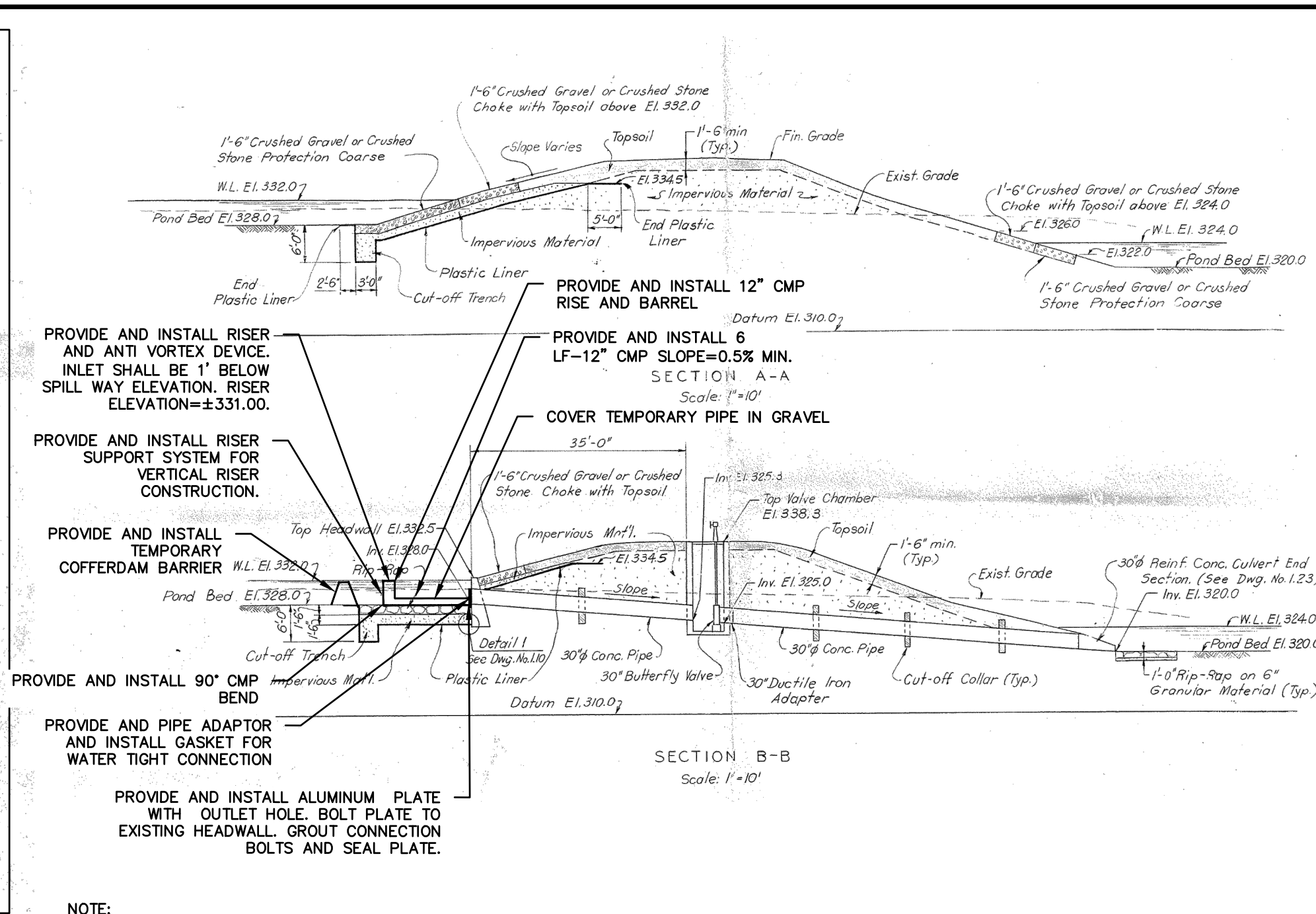
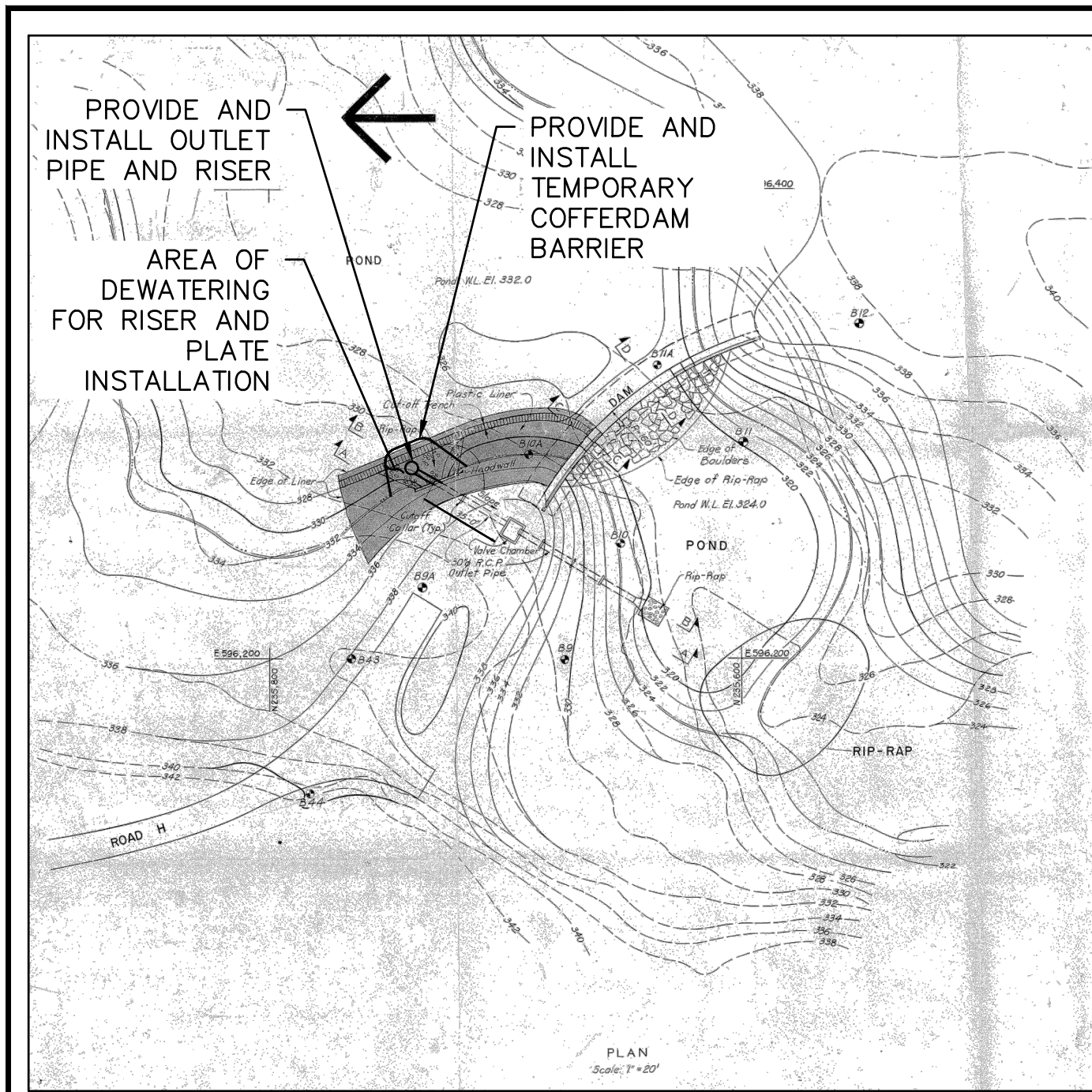

NOTE: THE DAM DETAILS ARE FROM THE PLAN TITLED "DAM-PLAN AND SECTIONS" FOR THE BRISTOL-MEYERS COMPANY PHARMACEUTICAL RESEARCH CENTER CREATED BY CLARKE AND RAPUANO INC AND THE STUBBINS ASSOCIATES INC.

CONTINGENCY AREA 4 - EXISTING DAM DETAILS

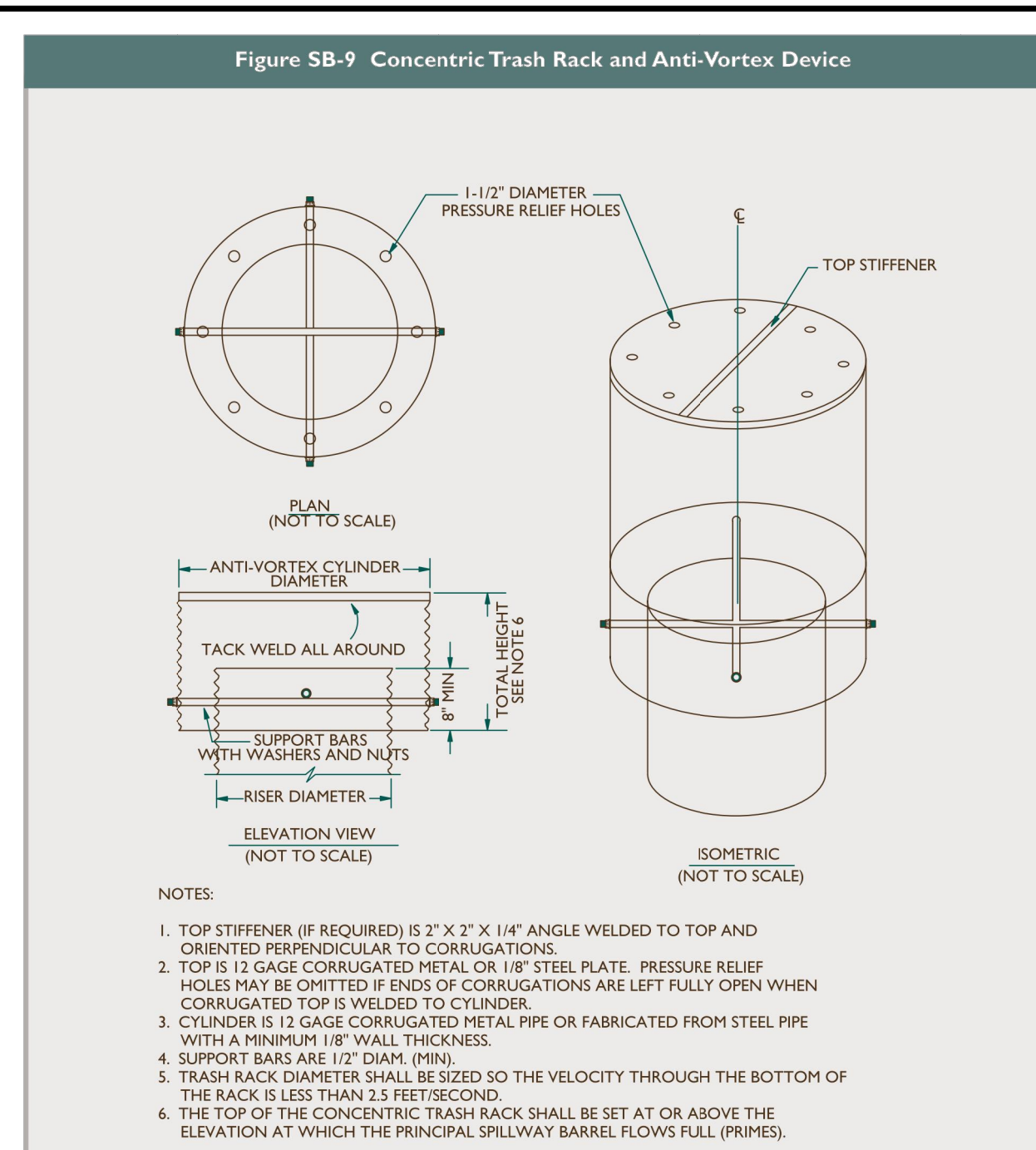

EROSION CONTROL CONTINGENCY PLAN NOTES

- DEPLOYMENT OF FLOC-LOGS SHALL BE AT THE DISCRETION OF THE ENVIRONMENTAL PLANNER, WATER DIVISION AND PROJECT ENGINEER.
 - SHOULD SEDIMENT ISSUES OCCUR, THE CONTRACTOR SHALL IMMEDIATELY NOTIFY THE TOWN ENVIRONMENTAL PLANNER AND THE PROJECT ENGINEER.
 - FLOC-LOGS SHALL BE USED IN AN EMERGENCY SITUATION, UPSTREAM OF TEMPORARY SEDIMENT TRAPS OR AS DIRECTED BY THE ENGINEER. THEY SHALL BE PLACED IN A SERIES ALONG THE ROUTE OF THE WATER SUCH THAT IT CAN FLOW AROUND OR OVER THEM INTO AND/OR OUT OF THE SEDIMENT TRAP.
 - IT WILL BE THE OWNERS RESPONSIBILITY TO CONTROL ALL WATER FEATURES ON SITE. THE WALLINGFORD WATER DIVISION (WWD) WILL NOT BE RESPONSIBLE FOR DIRECTION OF OPERATIONS, NOR OPERATION OF ANY STORMWATER CONTROL FEATURES INCLUDING THE OUTLET OF THE PONDS AT THE SITE. THE WWD WILL, HOWEVER, PROVIDE FEEDBACK AND RECOMMENDATIONS AS NECESSARY TO ASSIST THE OWNER AND/OR CONTRACTOR IN THEIR MAINTENANCE AND OPERATION OF THE SITE DURING CONSTRUCTION.
- AREA-1 & 2: PEDESTRIAN BRIDGE CROSSINGS**
- PRIOR TO COMMENCEMENT OF CONSTRUCTION, STOP-LOG BRACKETS SHALL BE MOUNTED ON THE EXISTING BRIDGE ABUTMENTS.
 - STOP-LOGS SHALL BE TEST-FITTED TO ASSURE PROPER FIT. STOP-LOG TEST-FIT SHALL BE REVIEWED BY THE ENGINEER.
 - STOP-LOGS SHALL BE STAGED ADJACENT TO THE PEDESTRIAN BRIDGES FOR EMERGENCY DEPLOYMENT.
- AREAS-3&4: EXISTING DETENTION BASIN ("SMALLER" POND) & EXISTING POND**
- PRIOR TO COMMENCEMENT OF ANY SITE WORK, THE HYDRAULIC CONNECTION BETWEEN THE PONDS SHALL BE REVIEWED AND DETERMINED WHETHER THE INTERCONNECTION PIPING IS A DISCHARGE PIPE OR IF IT ACTS AS A WATER SURFACE EQUALIZATION PIPE. RESULT SHALL BE REVIEWED WITH THE PROJECT ENGINEER.
 - SMALLER POND: IF CONNECTION IS NOT AN EQUALIZATION PIPE, A PUMP SHALL BE STAGED TO LOWER THE WATER SURFACE OF THE SMALLER POND. A FLOAT SHALL BE USED AT THE PUMP INTAKE TO ASSURE SURFACE WATER IS PUMPED. PUMPING PLAN SHALL BE PROVIDED TO THE WALLINGFORD ENVIRONMENTAL PLANNER, WALLINGFORD WATER DIVISION AND THE ENGINEER FOR REVIEW AND APPROVAL PRIOR TO DEPLOYMENT.
 - LARGER POND: PRIOR TO COMMENCEMENT OF CONSTRUCTION, THE CONTRACTOR SHALL BE EXERCISE THE POND DEWATERING VALVE WITH THE ENGINEER TO ASSURE PROPER FUNCTION.
 - SHOULD THE VALVE FUNCTION PROPERLY: THE CONTRACTOR SHALL COMMENCE WITH DEWATERING RISER INSTALLATION.
 - SHOULD THE VALVE NOT FUNCTION PROPERLY, THE CONTRACTOR WILL PROVIDE A PUMP WITH FLOAT AT INTAKE TO ASSURE ONLY SURFACE WATER IS REMOVED FROM THE POND. THE CONTRACTOR SHALL SUBMIT A PUMPING PLAN FOR REVIEW AND APPROVAL BY THE WALLINGFORD ENVIRONMENTAL PLANNER, WATER DIVISION AND PROJECT ENGINEER.

POND DRAW-DOWN CONSTRUCTION SEQUENCE

- PRIOR TO ANY CONSTRUCTION ACTIVITIES: THE FOLLOWING STEPS SHALL BE CONDUCTED:
 - HYDRAULIC CONNECTION BETWEEN "SMALLER" AND LARGER PONDS SHALL BE INVESTIGATED TO DETERMINE WHETHER IT IS A WATER SURFACE EQUALIZATION PIPE OF SMALLER POND DISCHARGE PIPE.
 - LARGER POND DRAWDOWN VALVE SHALL BE EXERCISED AND OPERATIONAL CAPABILITIES DETERMINED TO BE SUITABLE FOR DRAWDOWN OPERATIONS.
- CONTRACTOR SHALL PROVIDE PUMPING PLANS TO THE WALLINGFORD ENVIRONMENTAL PLANNER, WATER DIVISION AND PROJECT ENGINEER FOR REVIEW AND APPROVAL.
- UPON APPROVAL OF PUMPING PLANS, THE CONTRACTOR SHALL PROCEED WITH THE INSTALLATION OF THE LARGER POND RISER.
- ONCE COMPLETE, THE WATER SURFACE OF THE LARGER POND SHALL BE LOWERED APPROXIMATELY 12" UNLESS OTHERWISE DIRECTED.
- SHOULD THE PONDS BE INTERCONNECTED: THE SMALLER POND WATER SURFACE WILL ALSO BE LOWERED WITH THE LARGER POND. SHOULD THE PONDS NOT BE INTERCONNECTED, THE CONTRACTOR SHALL LOWER THE WATER SURFACE OF THE SMALLER POND 24".
- POND DRAW-DOWN SHALL OCCUR PRIOR TO ANY SITE WORK.
- POND DRAW-DOWN SHALL BE MAINTAINED THROUGHOUT THE CONSTRUCTION PROCESS, UNTIL ALL DISTURBED AREAS ARE PERMANENTLY STABILIZED.
- PRIOR TO THE DRAW-DOWN PROCEEDINGS, THE CONTRACTOR SHALL NOTIFY THE WALLINGFORD ENVIRONMENTAL PLANNER, THE WATER DIVISION AND THE PROJECT ENGINEER.
- PRIOR TO ANY STORM EVENT, THE WATER SURFACE OF THE PONDS SHALL BE REVIEWED AND DETERMINED WHETHER ADDITIONAL LOWERING IS REQUIRED.
- THE TIMING OF LOWERING THE WATER SURFACE SHALL BE AT THE DISCRETION OF THE WALLINGFORD ENVIRONMENTAL PLANNER IN CONJUNCTION WITH THE WALLINGFORD WATER DIVISION:
 - FOR THE SMALLER POND LOCATED AT CONTINGENCY AREA 3, A FLOATING PUMP OR SIPHON WILL BE USED TO REMOVE WATER FROM THE SURFACE TO REACH THE DESIRED DRAWDOWN VOLUME. THIS POND SHALL BE DRAWN DOWN UNTIL WATER LEVELS REACH 12".
 - FOR THE LARGER POND LOCATED AT CONTINGENCY AREA 4, THE DAM INCLUDES A DRAWDOWN VALVE. A RISER PIPE SHALL BE TIED INTO THE GATE VALVE. THIS VALVE SHALL BE OPENED TO ALLOW THE WATER TO DRAWDOWN UNTIL WATER LEVELS REACH 24". SHOULD THE GATE VALVE FAIL TO OPERATE, THE CONTRACTOR SHALL MAINTAIN PUMPING ABILITIES (I.E. HAVE BACK-UP PUMPS ON SITE) AND PROVIDE A PUMPING PLAN TO THE WALLINGFORD ENVIRONMENTAL PLANNER FOR REVIEW PRIOR TO COMMENCEMENT OF CONSTRUCTION. THE GATE VALVE SHOULD BE TESTED BY THE TOWN OF WALLINGFORD WATER AND SEWER DEPARTMENT PRIOR TO ANY DRAWDOWN EVENTS.
- TURBIDITY CURTAIN AND FLOCCULATES SHALL BE READILY AVAILABLE FOR USE AT THE OUTLETS IF THE PONDS APPEAR TURBID PRIOR TO DRAWDOWN ACTIVITIES. DEPLOYMENT IS AT THE DISCRETION OF THE ENGINEER.

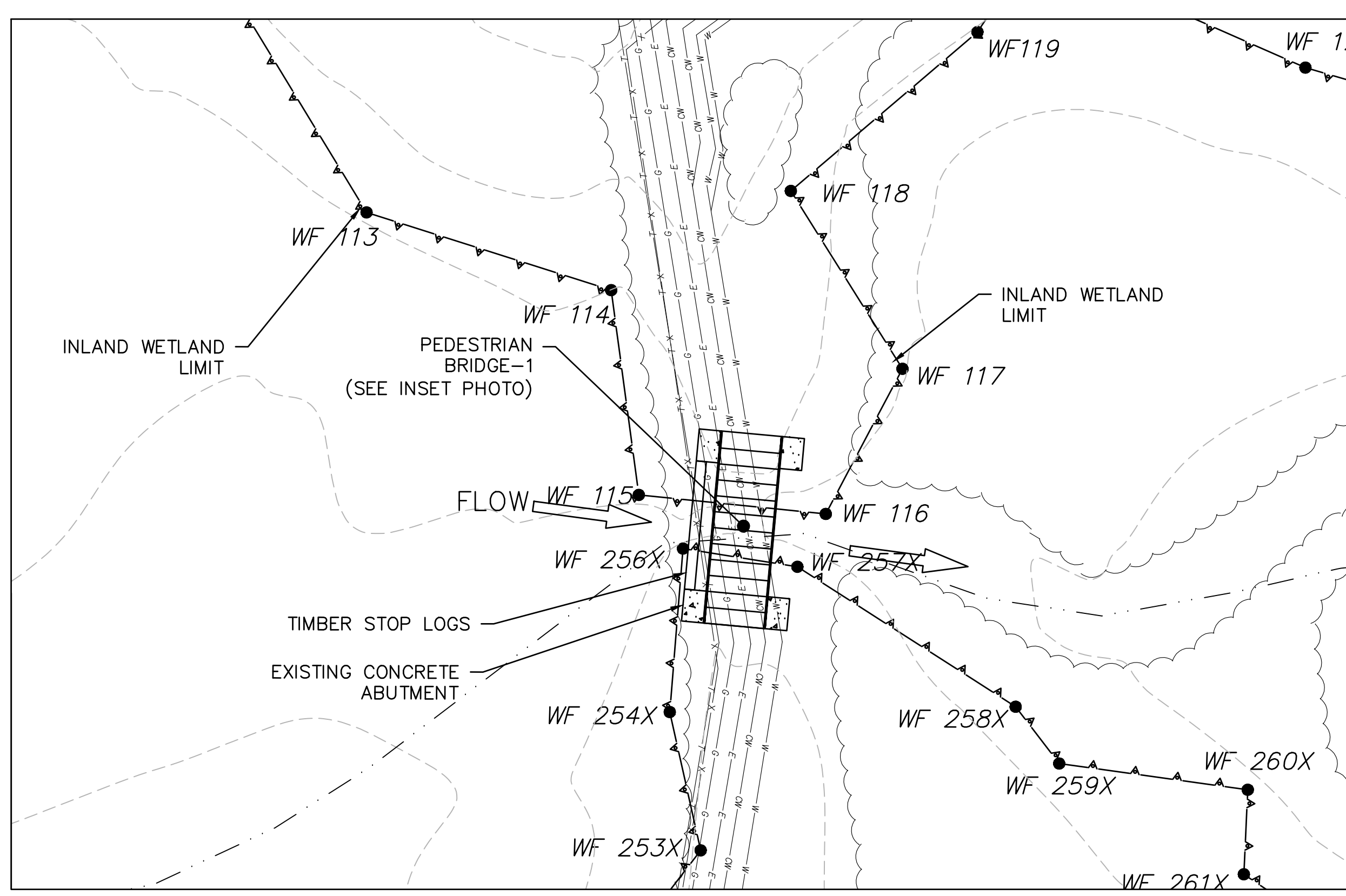

CONTINGENCY AREA 1

1"=20' BLEC-010

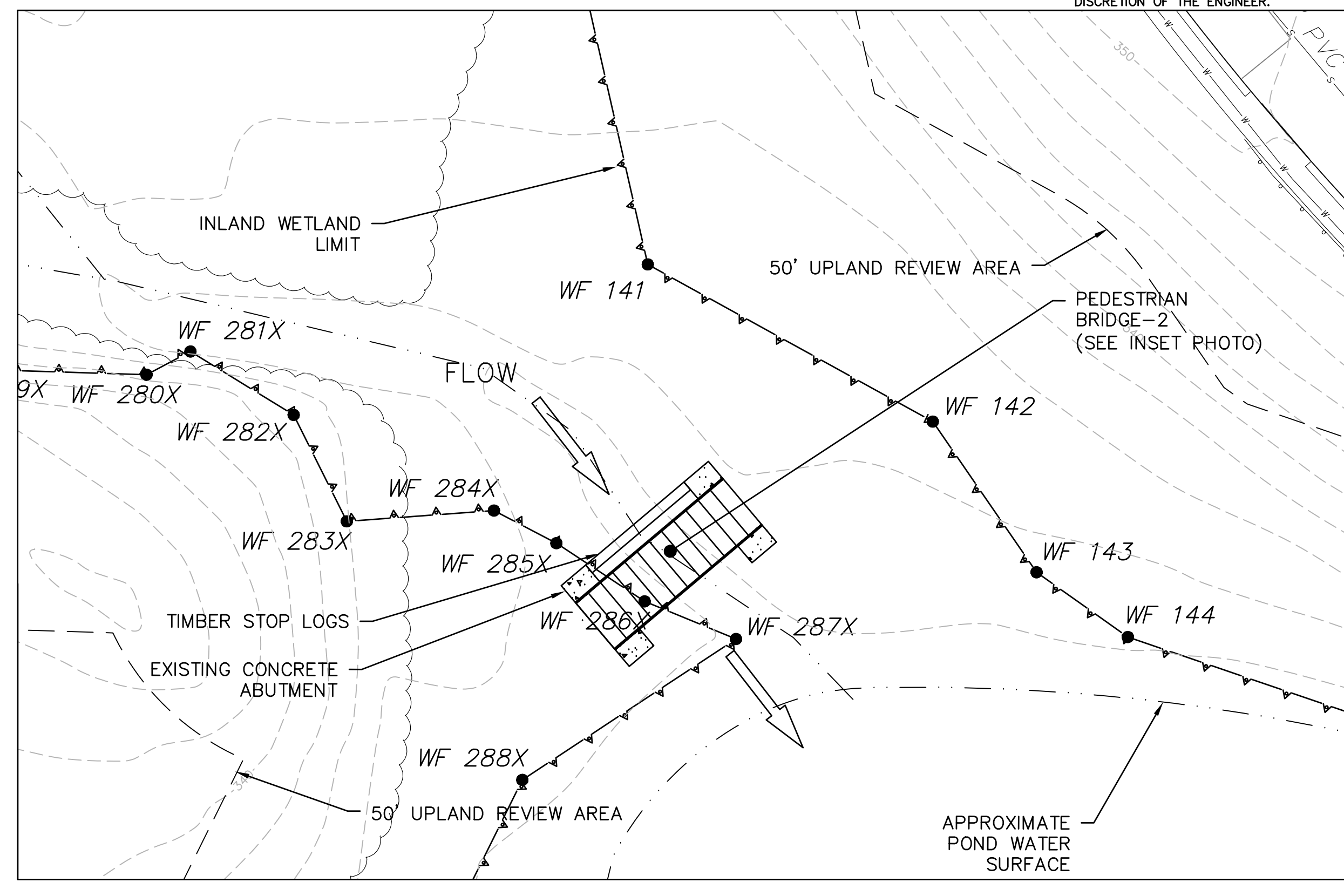

CONTINGENCY AREA 2

1"=20' BLEC-010

THE SITE LIES ENTIRELY WITHIN A PUBLIC WATER SUPPLY

FOR PERMITTING PURPOSES ONLY NOT RELEASED FOR CONSTRUCTION



REVISIONS

No.	Date	PER STAFF COMMENTS
1	12/21/2020	PER STAFF COMMENTS
2	03/09/2021	PER STAFF COMMENTS
3	04/07/2021	PER REVIEW COMMENTS
4	05/12/2021	PER WWC APPROVAL CONDITIONS

Designed	JD
Drawn	NAN
Reviewed	C.D.G.
Scale	NTS
Project No.	1901479
Date	12/21/2020
CAD File:	EC190147905

Title
EROSION CONTROL CONTINGENCY PLAN DETAILS

Sheet No.